



TOKISTAR LIGHTING INSTRUCTION MANUAL

TokiLux™ Series

24VDC

General Description

Tokistar's TokiLux Series operates at 24VDC. Light Bars are installed end-to-end within the TokiLux track. Each Light Bar contains five LEDs and consumes a total of 4 watts. An individual run length may contain up to 12 Light Bars. Multiple tracks can be interconnected with up to 12 Light Bars from a single feed point. Each track is labeled with wattage and operating voltage.

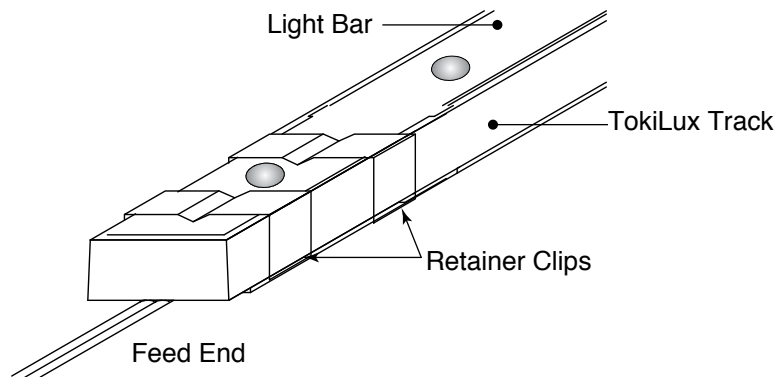

Maximum Run Length

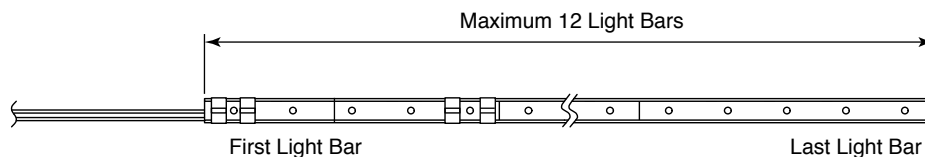

PRECAUTIONS

1. Read all instructions completely before beginning installation.
2. Turn off electricity before beginning installation.
3. All wiring is to be performed by a qualified electrician.
4. Installation must comply with the National Electrical Code, and all applicable codes.
5. Turn main supply to the LED driver on only after all connections have been made and tested.
6. Use only LED drivers provided by Tokistar with the system.

TOKISTAR® LIGHTING

1015 E. Discovery Lane
Anaheim, CA 92801

TEL: 714 772 7005 FAX: 714 772 7014
email: info@tokistar.com Website: tokistar.com

Connectors

Feed Connector

Part#: TLX-CON

Feed Connectors bring power to one end of a TokiLux run. Up to 12 Light Bars can be powered from a single connector.

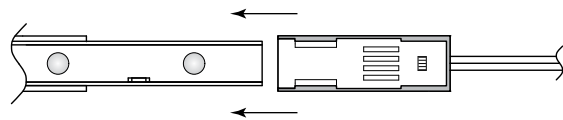

Do Not Snap Connectors in place from above. Slide in place.

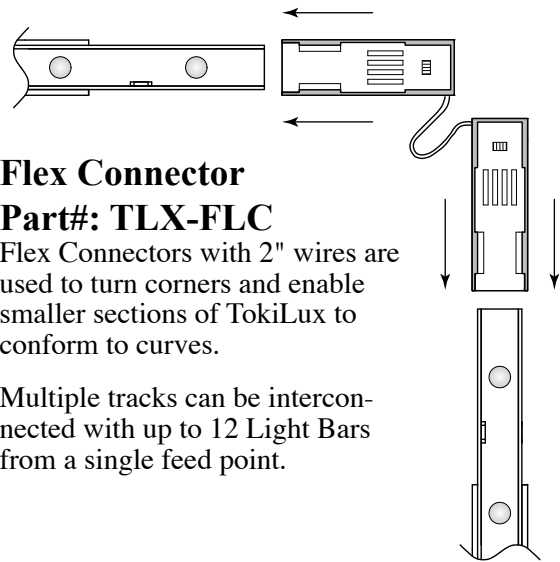

Flex Connector

Part#: TLX-FLC

Flex Connectors with 2" wires are used to turn corners and enable smaller sections of TokiLux to conform to curves.

Multiple tracks can be interconnected with up to 12 Light Bars from a single feed point.

Retainer Clips

Retainer clips are included with Feed Connectors and Flex Connectors. These snap onto the fixture to provide a secure connection.

Feed Connector Assembled

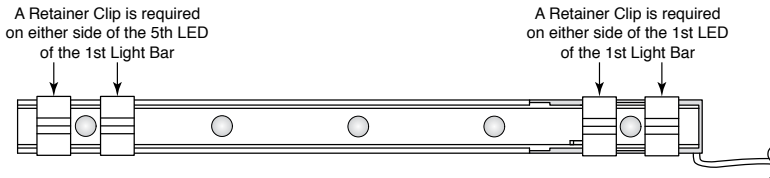

A Retainer Clip is required on either side of the 5th LED of the 1st Light Bar

A Retainer Clip is required on either side of the 1st LED of the 1st Light Bar

Retainer Clips snap in place from above.

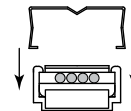

Flex Connector Assembled

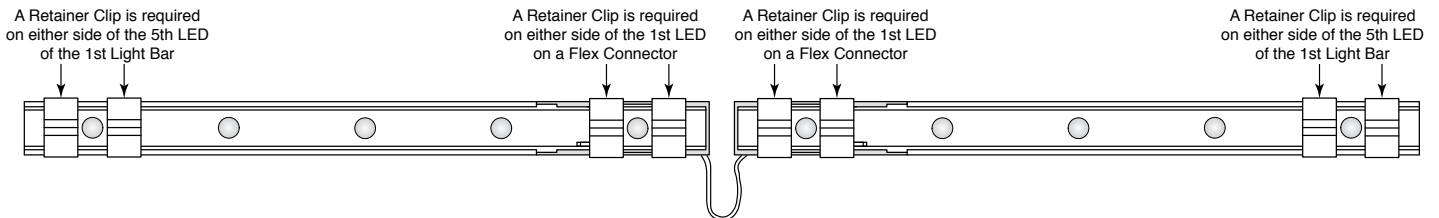

A Retainer Clip is required on either side of the 5th LED of the 1st Light Bar

A Retainer Clip is required on either side of the 1st LED on a Flex Connector

A Retainer Clip is required on either side of the 1st LED on a Flex Connector

A Retainer Clip is required on either side of the 5th LED of the 1st Light Bar

End Cap

Part #: TLX-ED

End Caps insulate the end of a run of TokiLux.

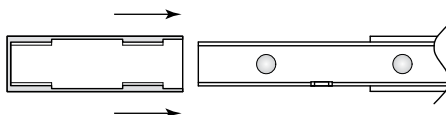

Mounting Clamp

Part #: TLX-CP

Mounting clamps are attached with screws and the Tokilux fixture is snapped in place. Recommended spacing is every 12".

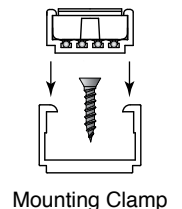

Mounting Clamp

Fixture Lengths

Fixtures cannot be trimmed on site, so the overall length is based upon the number of Light Bars included. Check the sizes and lengths chart for precise measurements.

Part Number	Bars	Watts	Length	
TLX-(Ordering Code)-1	1	4	8"	200 mm
TLX-(Ordering Code)-2	2	8	15.875"	400 mm
TLX-(Ordering Code)-3	3	12	23.75"	600 mm
TLX-(Ordering Code)-4	4	16	31.625"	800 mm
TLX-(Ordering Code)-5	5	20	39.5"	1,000 mm
TLX-(Ordering Code)-6	6	24	47.375"	1,200 mm
TLX-(Ordering Code)-7	7	28	55.25"	1,400 mm
TLX-(Ordering Code)-8	8	32	63.125"	1,600 mm
TLX-(Ordering Code)-9	9	36	71"	1,800 mm
TLX-(Ordering Code)-10	10	40	78.875"	2,000 mm
TLX-(Ordering Code)-11	11	44	86.75"	2,200 mm
TLX-(Ordering Code)-12	12	48	94.625"	2,400 mm

Secondary Circuit Wiring

A maximum of 24 Light Bars can be powered on one circuit from the power supply.

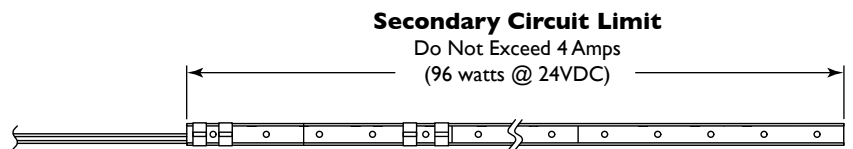

Recommended Lead Wire Size

Leads on feed connectors are 6 ft. long. Additional lead wire may be spliced on by the installer in order to reach remote LED driver locations. The length of and the load on the secondary circuit will determine the proper size of secondary wire. This chart provides recommended length of the secondary circuit using #18 AWG based upon the loads shown.

Secondary Lead Wires	
Load / Amps	Wire Length
24 watts / 1 amp	130' (40 M)
48 watts / 2 amps	98' (30 M)
72 watts / 3 amps	65' (20 M)
96 watts / 4 amps	32' (10 M)

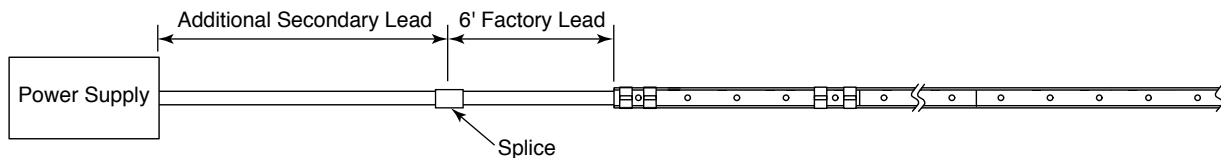

LED Driver Installation

LDR24-96

This 96 Watt Class 2 LED driver converts an AC input into a 24VDC output. Refer to the manual provided with the LED driver for detailed installation instructions.

Part#	Input Volts	Output Volts	Output Ratings
LDR24-96	100~277	24VDC	1 @ 4 Amps

LDR24-192

Tokistar's LDR24-192 has two independent 96 watt outputs. If the system is dimmed, each output requires an independent dimmer pack. This unit has wiring compartments for splicing on input and output leads, and can be connected directly to conduit. Refer to the manual provided with the LED driver for detailed installation instructions.

Part#	Input Volts	Output Volts	Output Ratings
LDR24-192	100~277	24VDC	2 @ 4 Amps

LED Dimmer Instructions

0/1-10VDC Dim Card

Part #: LDR-DIM

This component connects to the secondary output of our LED drivers and works from industry-standard 0/1-10VDC dimmers. The output to our fixtures is Pulse Width Modulation (PWM) for flicker-free operation. Our dual output LDR24-192 driver requires two dim cards.

Max. Load: 96 Watts/4 Amps

Capacity: 4 Watt Light Bars/24 each

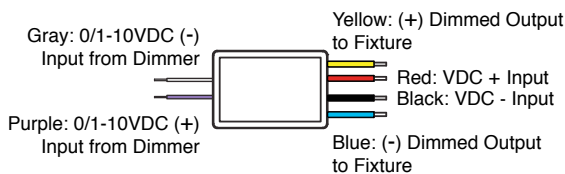

Dim Card

Dim Cards are installed externally to our LED drivers.

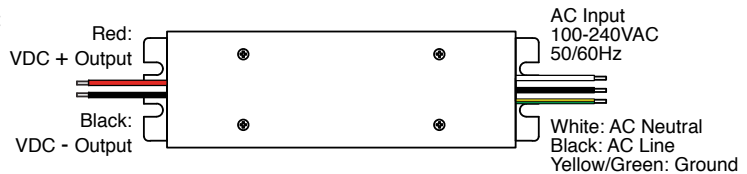

LED Driver

LC Dimming System

Wall Dimmer - Part #: LC-DMR

Power to the remote wall dimmer is provided from the LED driver powering the first dimmer pack. A 50 foot CAT5 cable is provided.

Dimmer Pack - Part #: LC-1CH-DP

Each dimmer pack receives an 24VDC output from an LDR24-96 LED driver. The LDR24-192 LED driver has 2 each 24VDC outputs, and a dimmer pack is required for each output. A CAT5 cable is provided with each unit. Up to 25 dimmer packs may be connected in series if the total length of all CAT5 cable does not exceed 165 feet from wall dimmer to last dimmer pack.

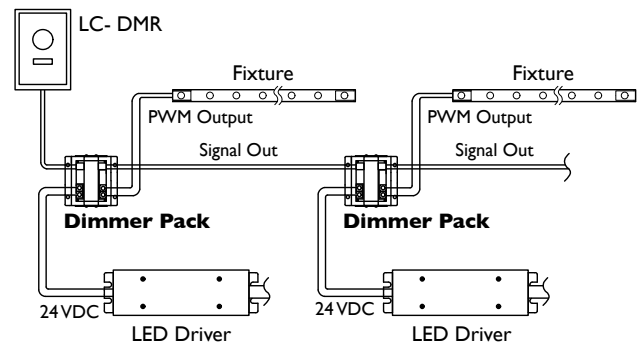

For further information, refer to the instruction manuals provided with the units.

LC-1CH-MULTI Dimming System

Tokistar's LC-1CH-MULTI Dimmer Pack is compatible with industry-standard dimmers working on DMX or 0/1-10VDC protocol. In the manual mode, a preset light level can be set without the use of an external dimmer.

Dimmer Pack - Part #: LC-1CH-MULTI

Each dimmer pack receives an 24VDC output from an LDR24-96 LED driver. The LDR24-192 LED driver has 2 each 24VDC outputs, and a dimmer pack is required for each output.

DMX Mode - Each unit is independently addressable. Up to 36 dimmer packs may be connected in series. For applications exceeding 36 dimmer packs, an additional feed from the DMX dimmer is required. The additional feed(s) can be sent directly from the dimmer, or you may use DMX Splitters.

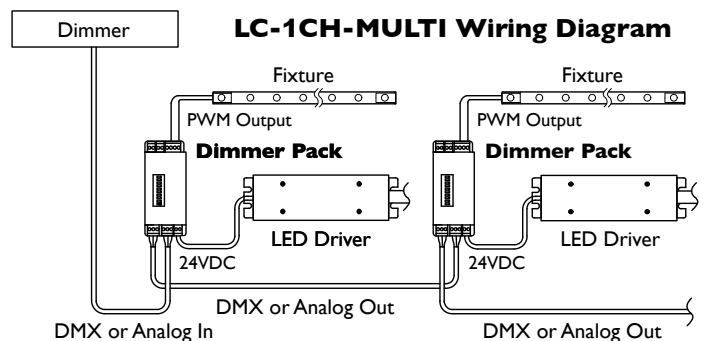

Analog Mode 0/1-10VDC - For operation from devices using 0/1-10VDC protocol, up to 10 dimmer packs may be connected in series. For applications exceeding 10 dimmer packs, an additional feed from the analog dimming device is required.

PRECAUTION

All dimming components are rated for dry location only. They must be installed within an enclosure suitable for the environment.